



# HEXAGONLIVE

Innovation Summit  
3 September 2025 | Korea

정밀 측정과 스마트 디지털 트윈의 미래

2025. 9. 3(수) | aT센터 그랜드홀(5층)



# 스캔부터 분석까지, Leica Geosystems로 구현하는 Reality Capture

차호영 책임

Leica Geosystems

# 스캔부터 분석까지, Leica Geosystems로 구현하는 Reality Capture

## ■ Reality Capture ???

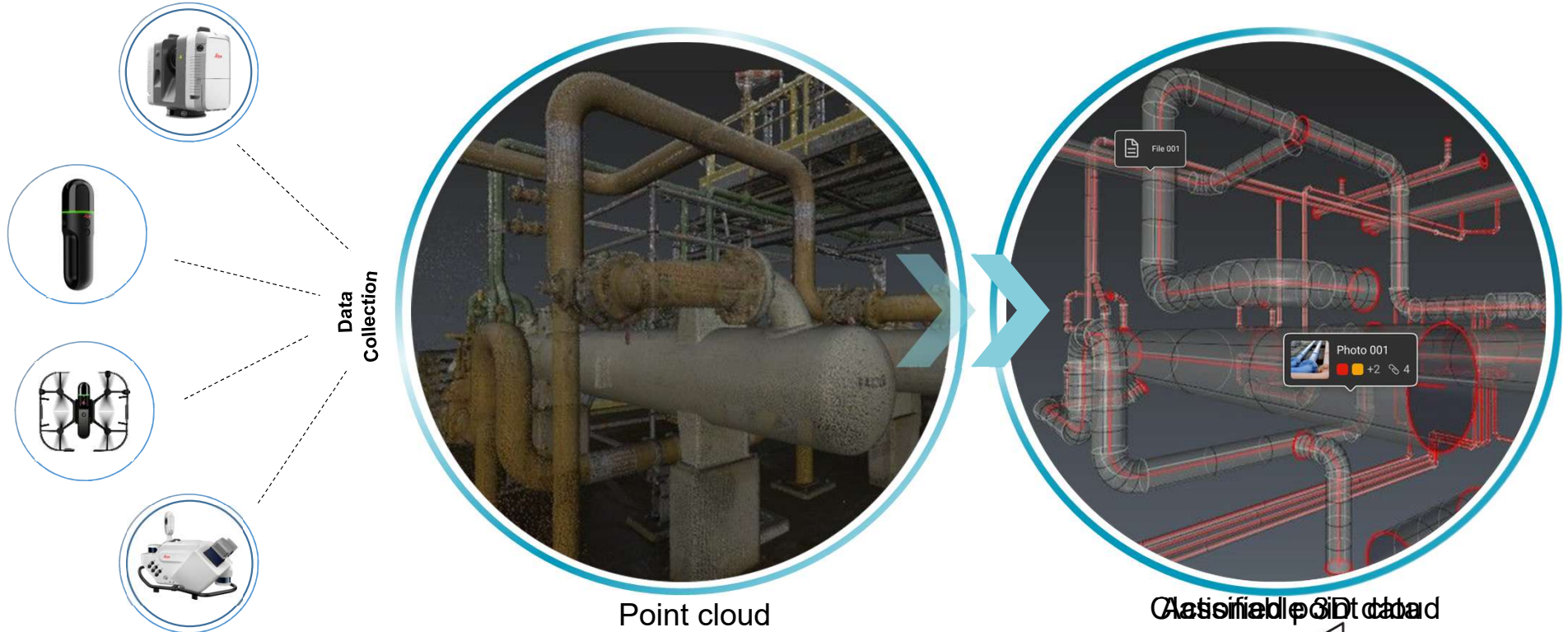

# 스캔부터 분석까지, Leica Geosystems로 구현하는 Reality Capture

## Reality Capture의 워크플로우

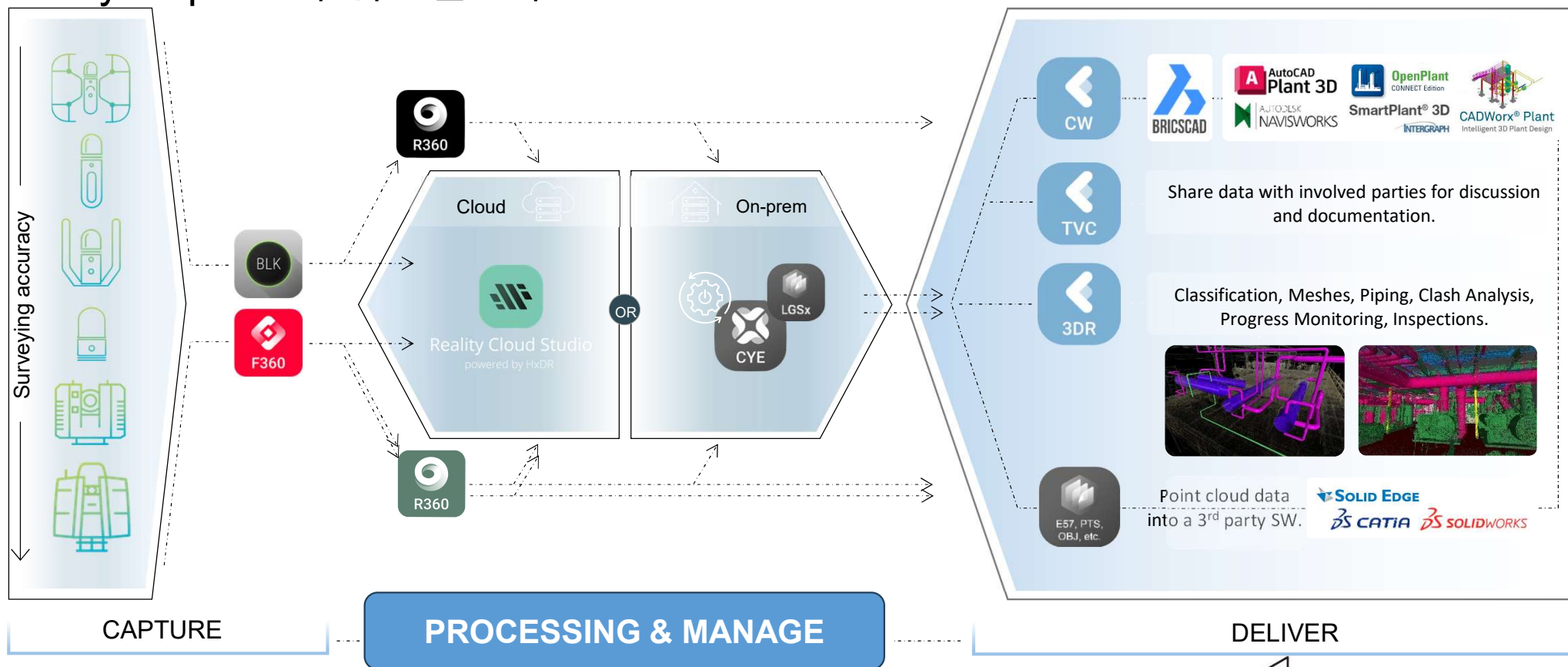

# 스캔부터 분석까지, Leica Geosystems로 구현하는 Reality Capture

- Processing
  - Cyclone REGISTER 360 PLUS(Classification)

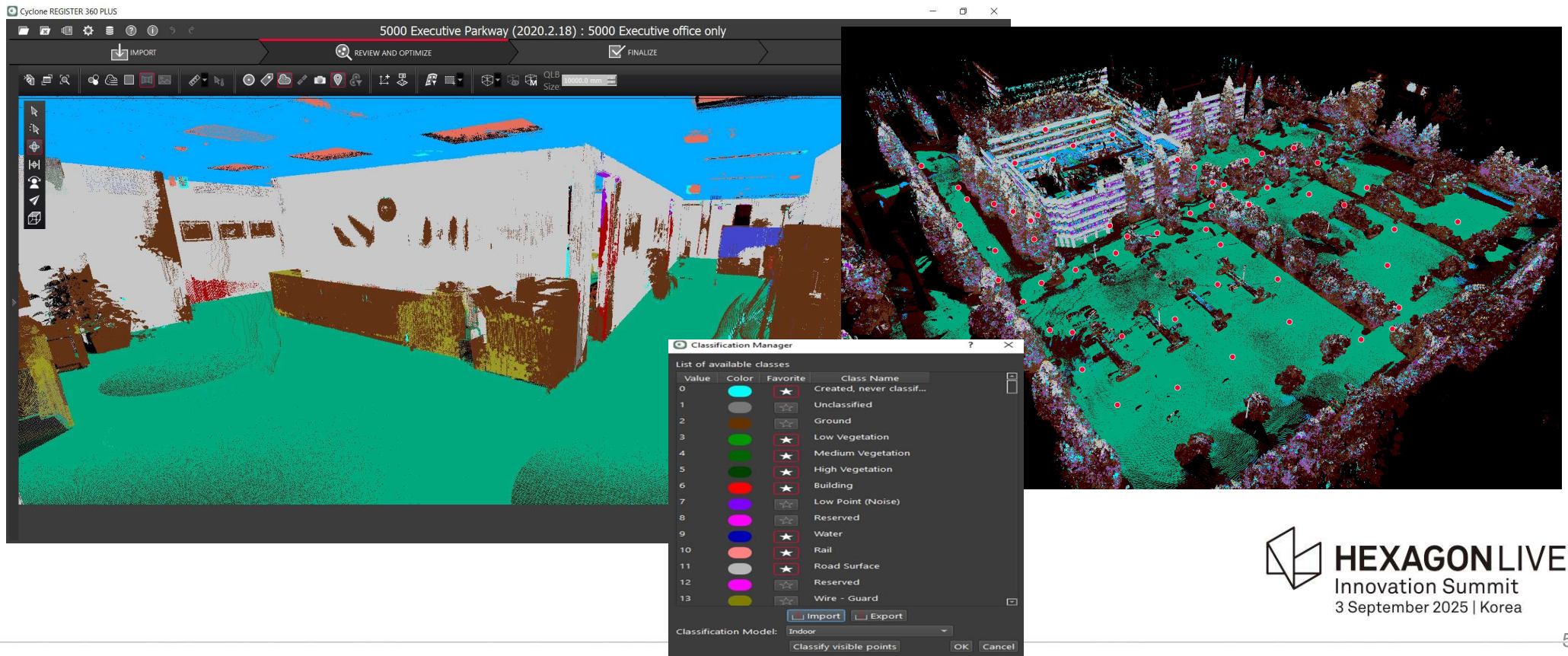

# 스캔부터 분석까지, Leica Geosystems로 구현하는 Reality Capture

- Processing

- Cyclone REGISTER 360 PLUS(Vivid Colors)



Normal



Vivid colors



Mesh

# 스캔부터 분석까지, Leica Geosystems로 구현하는 Reality Capture

## Manage

### Cyclone ENTERPRISE

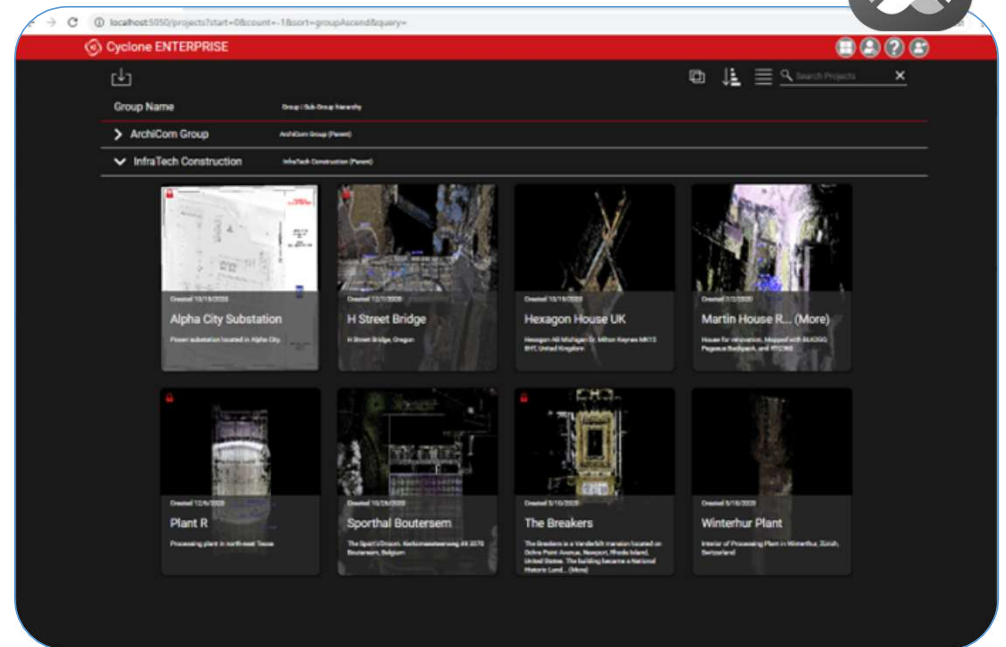
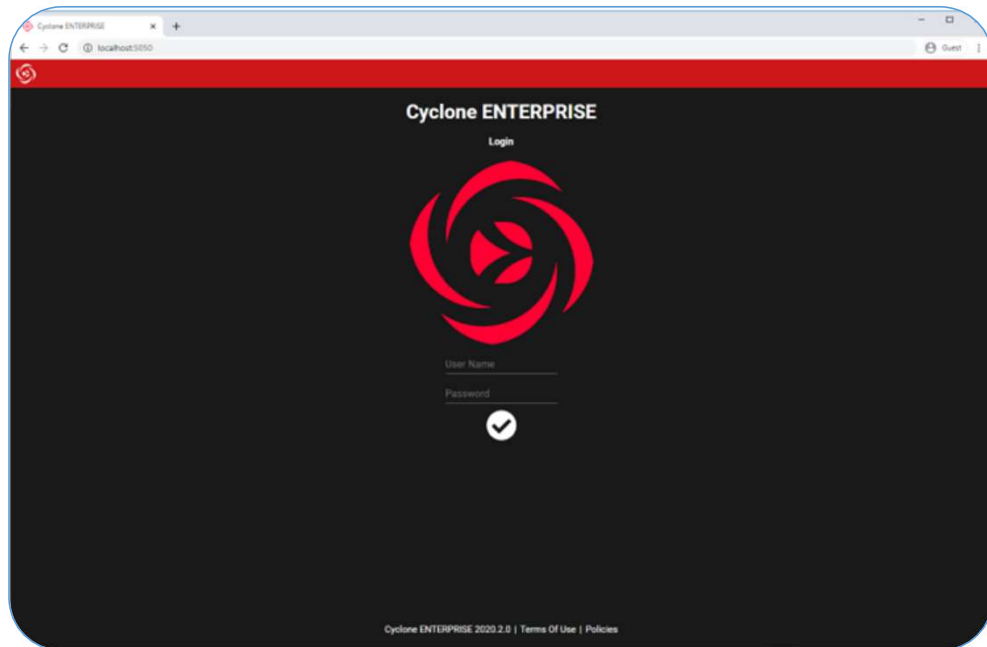

- Local Server
- Amazon Web Services
- Microsoft Azure

# 스캔부터 분석까지, Leica Geosystems로 구현하는 Reality Capture

- Manage
  - Cyclone ENTERPRISE(TruView LIVE)

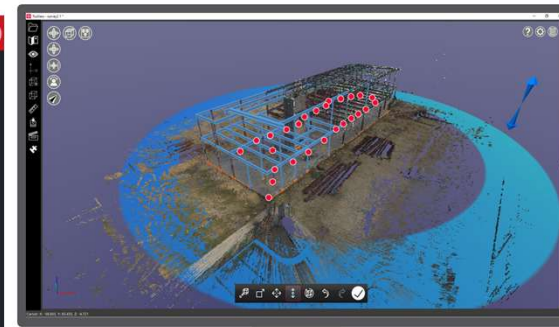
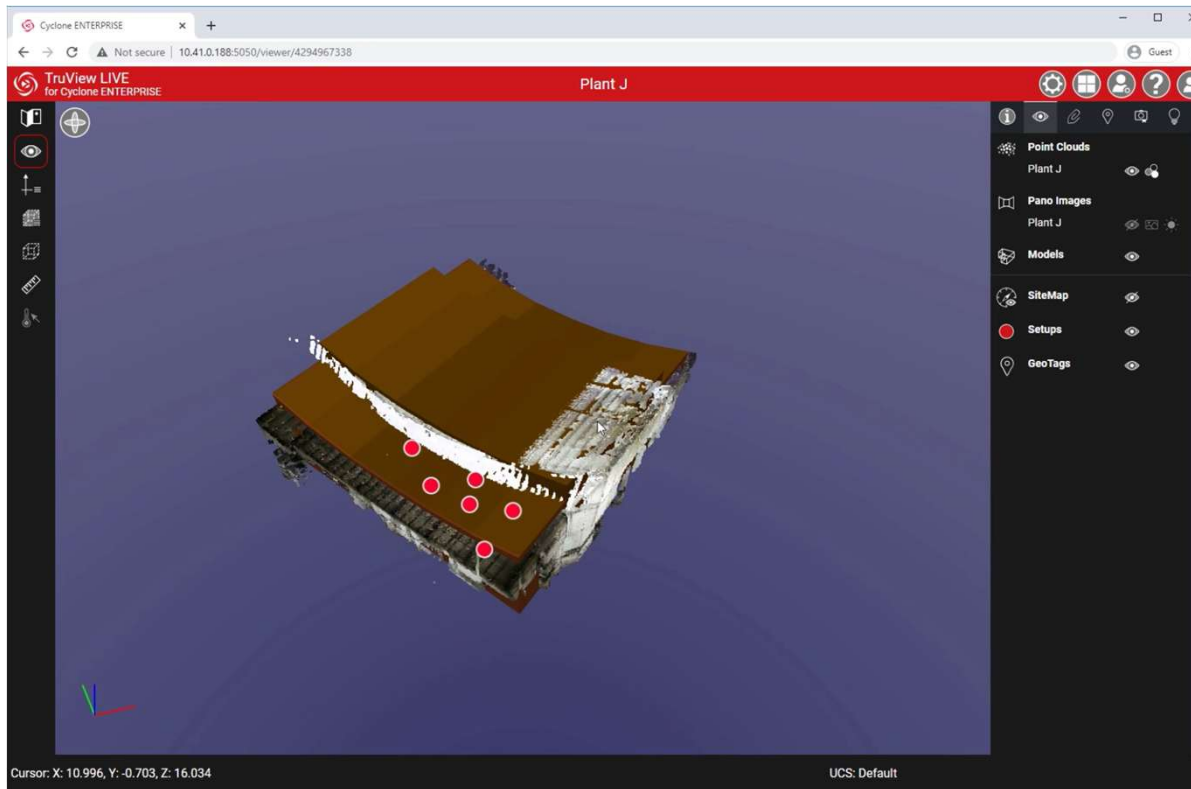

Add and align models in TruView



Web-based visualisation, touring, and inspection for stakeholders

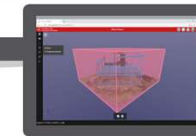

Create temporary clips on-the-fly for easy, visual on-site ground truthing

**Anywhere, Anytime, Any Device.**

 **HEXAGON LIVE**  
Innovation Summit  
3 September 2025 | Korea

# 스캔부터 분석까지, Leica Geosystems로 구현하는 Reality Capture

## Reality Capture의 워크플로우

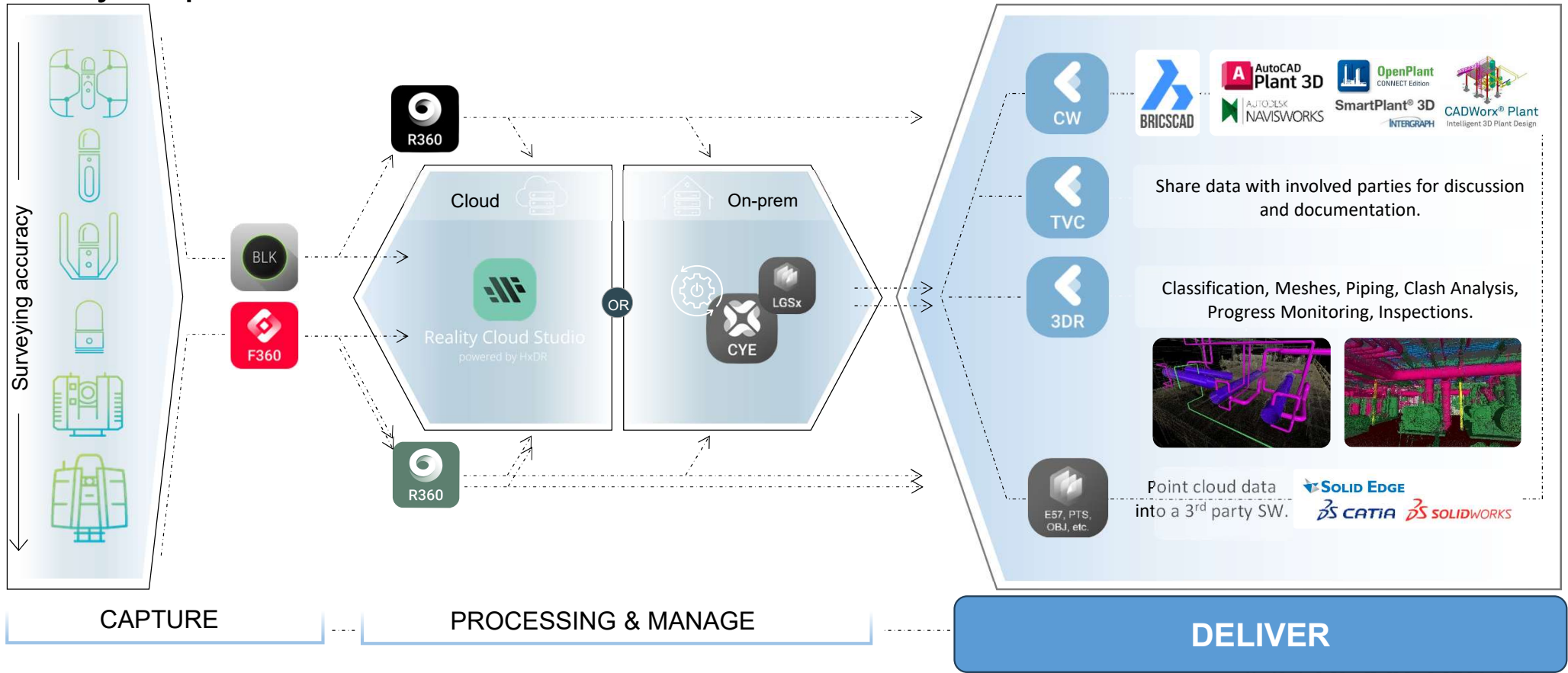

# 스캔부터 분석까지, Leica Geosystems로 구현하는 Reality Capture

- Deliver - 데이터 분석 및 모델링
  - Cyclone 3DR

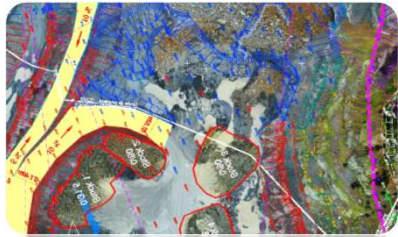

LAND SURVEYING

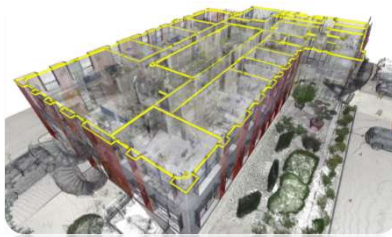

ARCHITECTURE

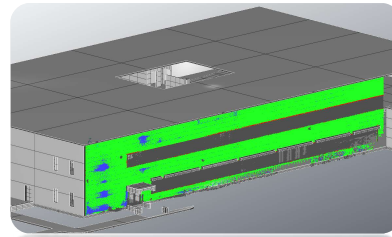

CONSTRUCTION

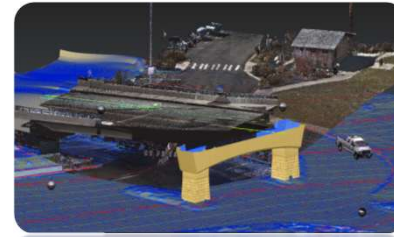

CIVIL ENGINEERING



CULTURAL HERITAGE



MINE & QUARRY

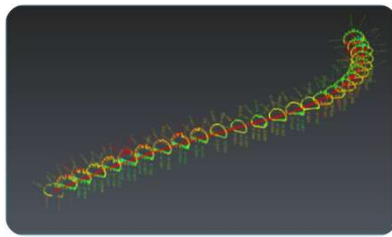

TUNNELS

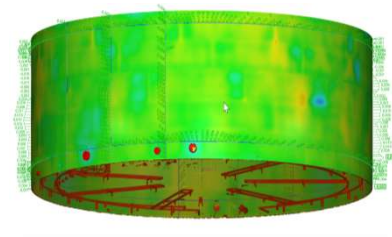

STORAGE TANK

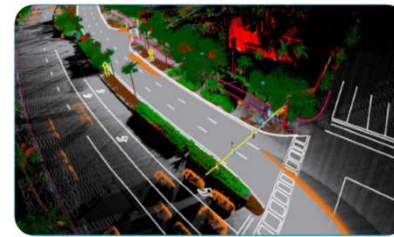

UTILITY

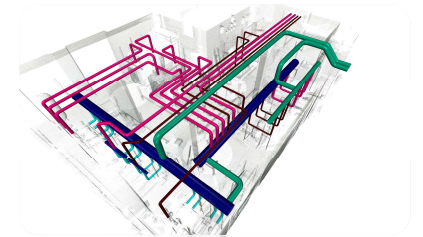

POWER & PLANT



# 스캔부터 분석까지, Leica Geosystems로 구현하는 Reality Capture

- Deliver - 데이터 분석 및 모델링
  - Cyclone 3DR edition

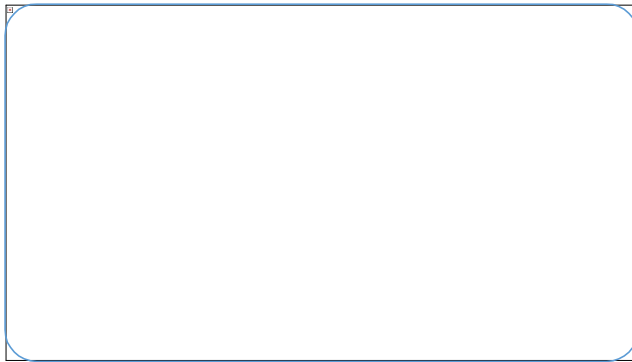

## SURVEYING

- Tunneling / bridges
- Stockpile
- DTM/DSM
- Volumetric
- Texturing
- 2D Survey Map
- Points on Grid
- Alignment, Profile, Contours and more...

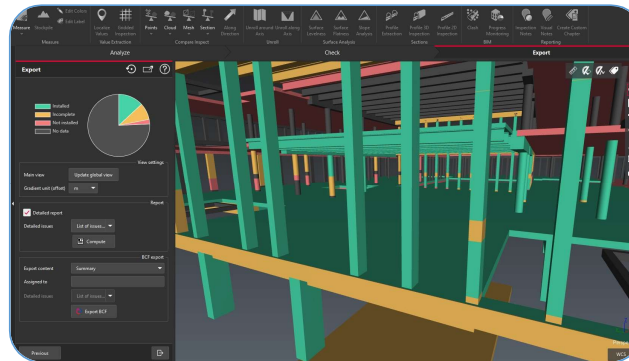

## AEC

- CAD/ BIM Alignment
- Construction verification
- CAD/BIM Model inspection
- Visual inspection
- Surface analysis + ASTM-FF/FL
- Monitoring
- Feature extraction
- Scan to Plan
- Clash analysis
- Touch BIM Inspection workflow
- BIM Progress Monitoring

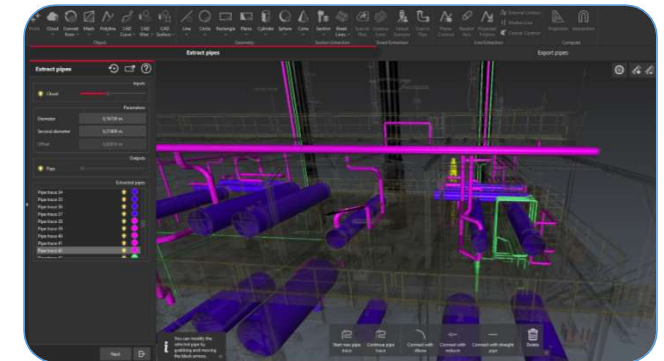

## PLANT

- API 653 TANK Inspection workflow
- Scan to Pipe
- CAD/BIM Alignment
- CAD/BIM Model inspection
- Visual inspection

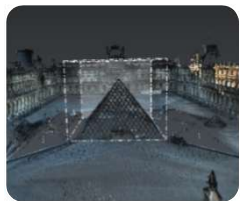

Point cloud Management



Meshing / ScanToMesh Surface Modeling

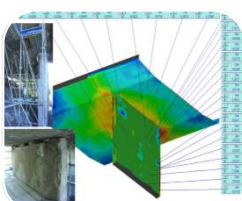

Comparison Inspection

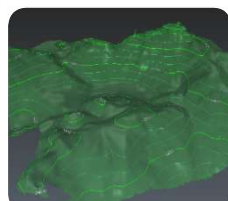

Basic Feature Extraction



Scripting

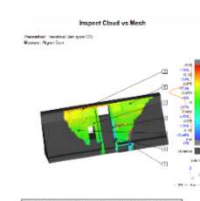

Reporting

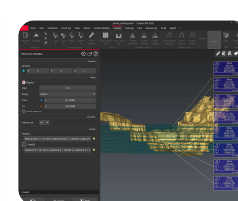

Measurement & Analysis Tools

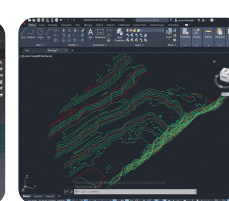

Standard CAD Interoperability

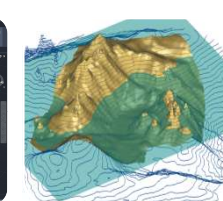

Advanced Extraction Features

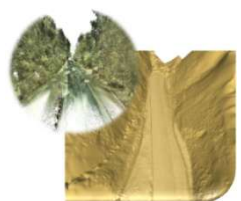

Advanced Modeling DTM - DSM

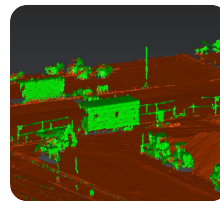

Advanced Cleaning Features

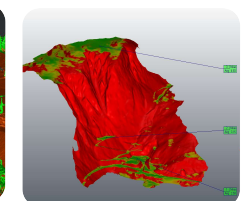

Surface Analysis



Texturing

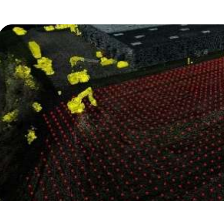

Points On Grid

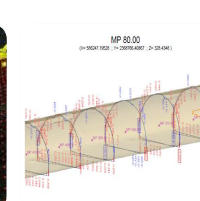

Cross Section Workflow



2D Survey Map

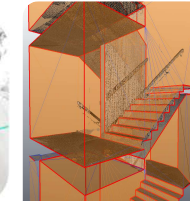

Building Extractor

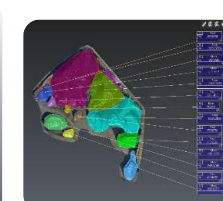

Stockpile Analysis

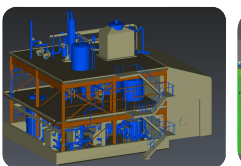

Import IFC & RVT

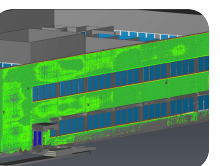

BIM / CAD Model Inspection

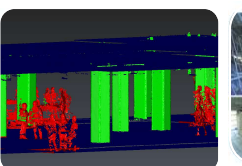

Advanced Cleaning Features

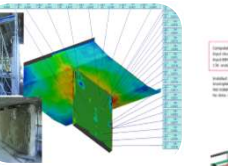

Advanced Surface Analysis



Progress Monitoring

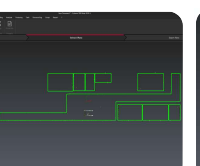

Scan to Plan

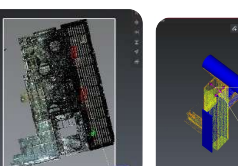

Clash Analysis

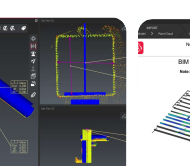

Visual Notes

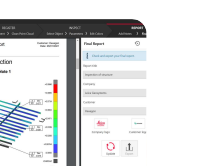

Touch BIM Inspection

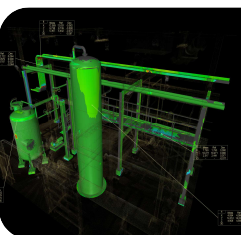

Model Inspection

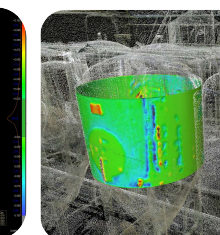

Tank Inspection

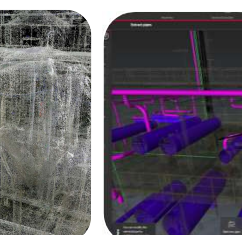

Scan to Pipe

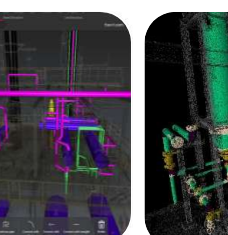

Point Cloud Classification

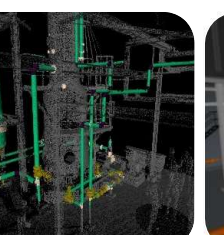

Import IFC & RVT

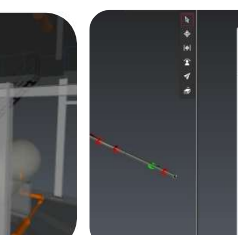

Clash Analysis

# 스캔부터 분석까지, Leica Geosystems로 구현하는 Reality Capture

- Deliver - 데이터 분석 및 모델링
  - Cyclone 3DR(AI Point Cloud Classification)



Indoor Generic



Indoor Construction Site

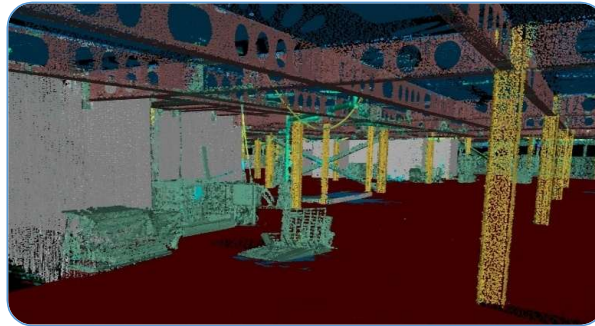

Plant | Piping

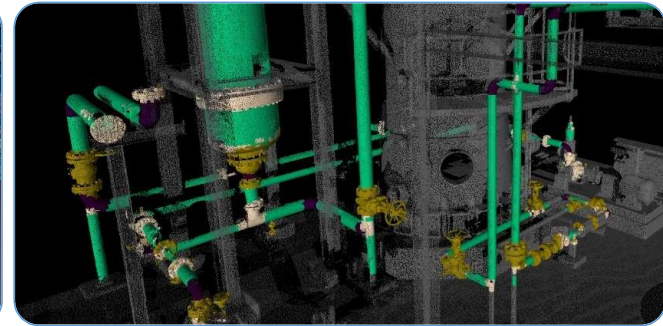

- BLK Mobile Filter People 2.0
- Heavy Construction UAV 1.1
- Indoor 2.2
- Indoor Construction Site 1.3
- Outdoor TLS 2.1
- Plant 1.0
- Road 1.0

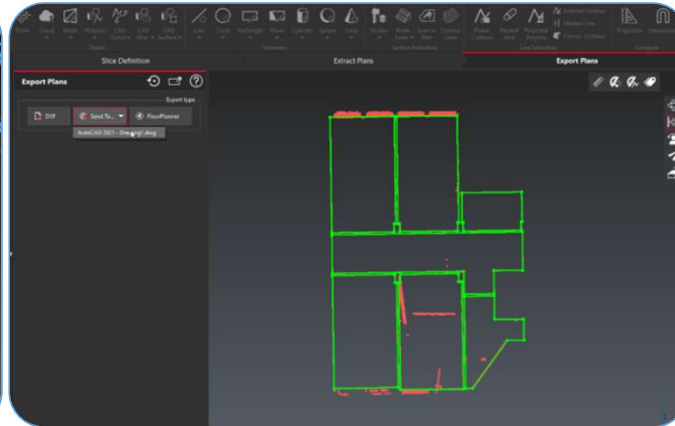
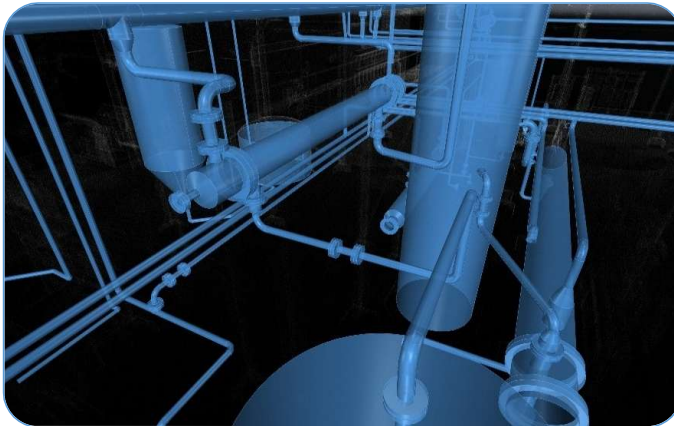

# 스캔부터 분석까지, Leica Geosystems로 구현하는 Reality Capture

- Deliver - 데이터 분석 및 모델링
  - Cyclone 3DR(Smart Object Segmentation)

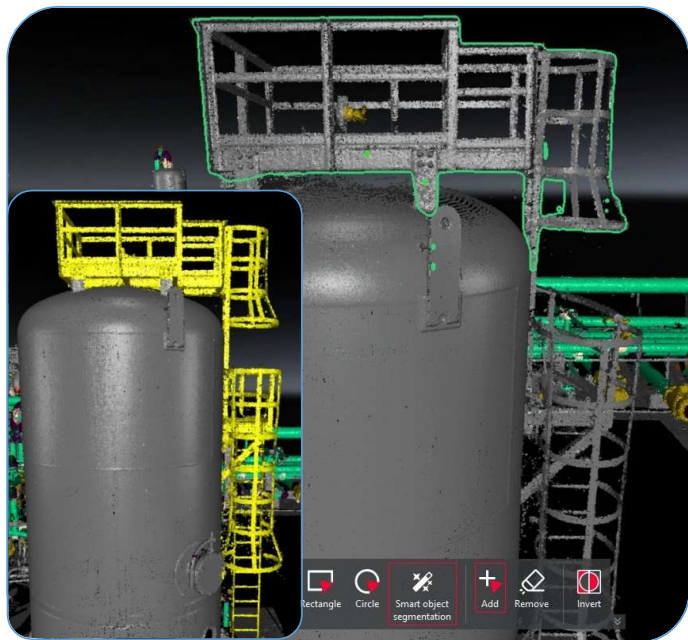

## Point Clouds

Clean | Manual Classification

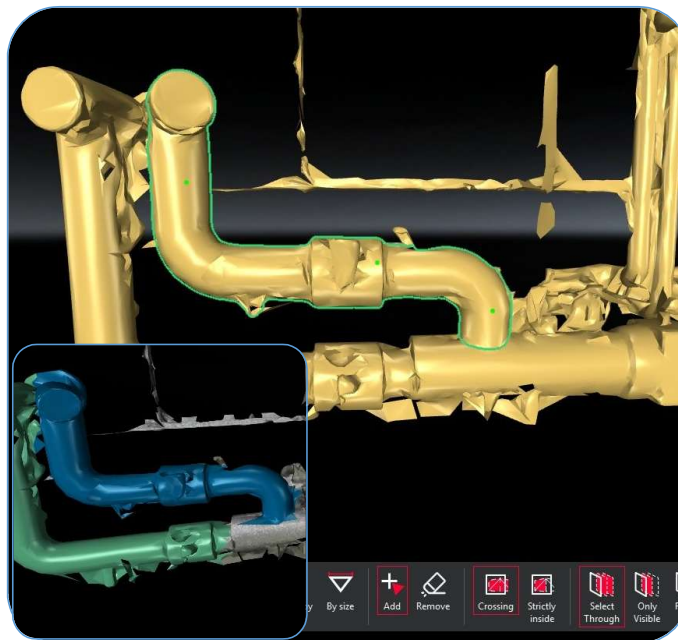

## Meshes

Clean

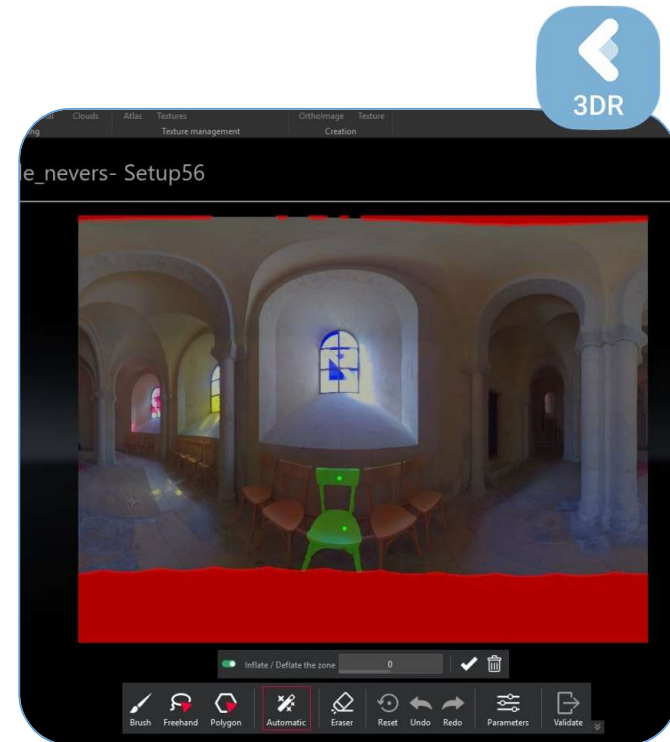

## Images

Edit Mask

# 스캔부터 분석까지, Leica Geosystems로 구현하는 Reality Capture

- Deliver - 데이터 분석 및 모델링
  - Cyclone 3DR(Scripting)



```

Script - Untitled*
1 //Open up a file at the user's preferred location
2
3
4 var pointsFile = GetSaveFileName("Choose where to save points file", "*.
  csv", CurrentScriptPath())
5 var file = SFile.New(pointsFile);
6
7
8 //CHECK IF THE FILE EXISTS AND GET LAST POINT NUMBER
9
10 function FileExists(checkFile)
11 {
12     // Default values if no other values found
13     var pointNumber = 0;
14     var featureCode = "FC";
15     var comment = "Comment";
16
17     //print("file exists")
18     checkFile.Open(SFile.ReadOnly);
19     var alllines = checkFile.ReadAll().split('\n');
20     if (alllines.length > 0){
21
22
23         var lastFeature = alllines[alllines.length-2].split(',')
24
25         checkFile.Close();
26
27         pointNumber = parseInt(lastFeature[0]) + 1;
28         featureCode = lastFeature[4];
    
```

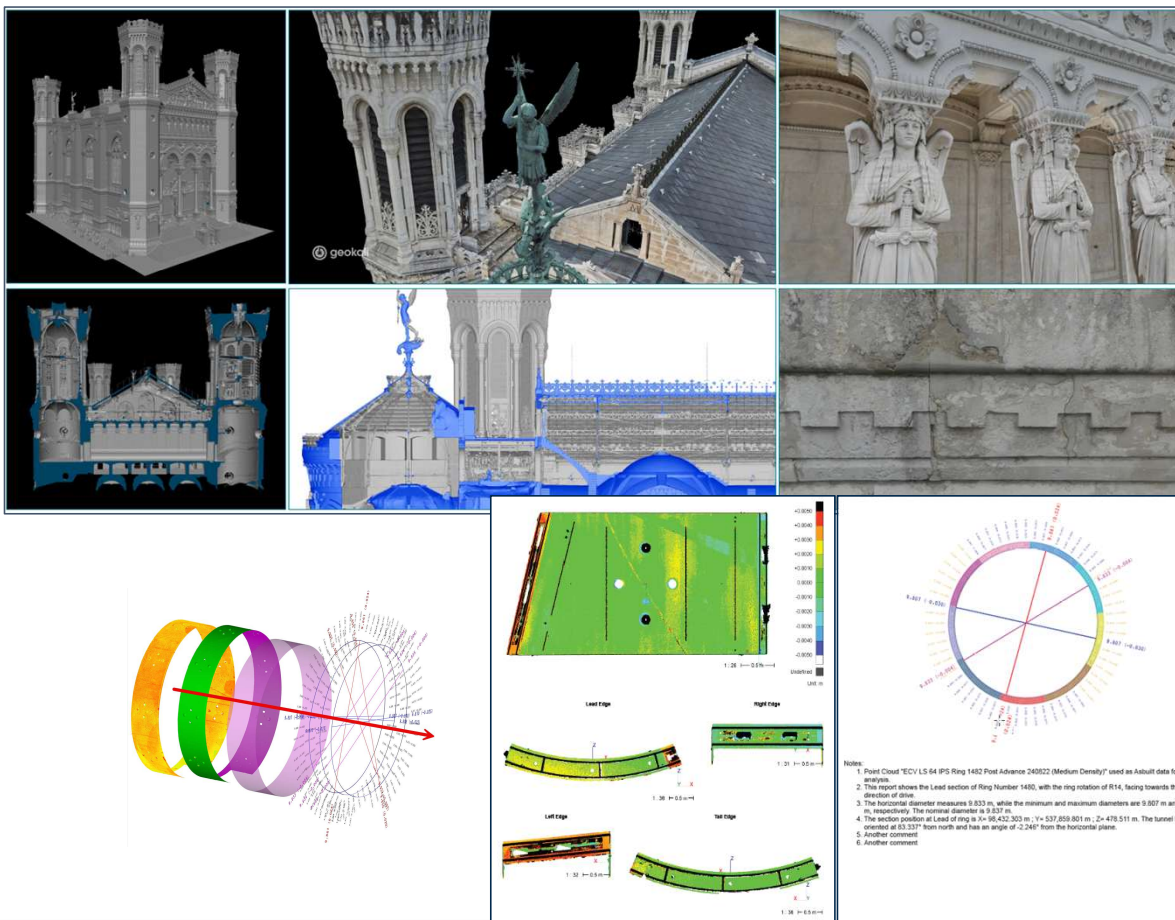

AGONLIVE  
ion Summit  
ber 2025 | Korea

# 스캔부터 분석까지, Leica Geosystems로 구현하는 Reality Capture

- Deliver - 모델링
  - CloudWorx

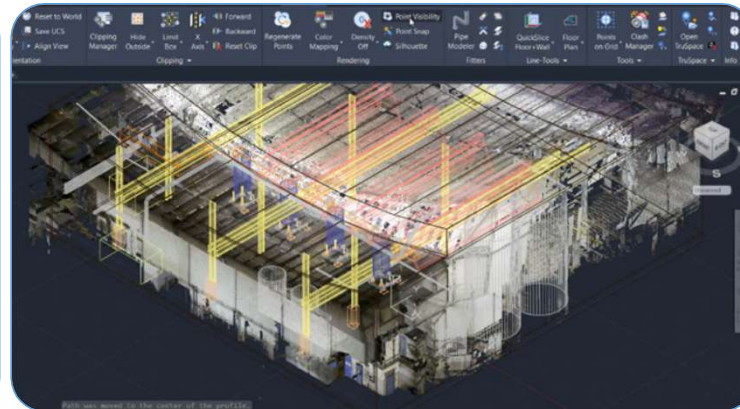
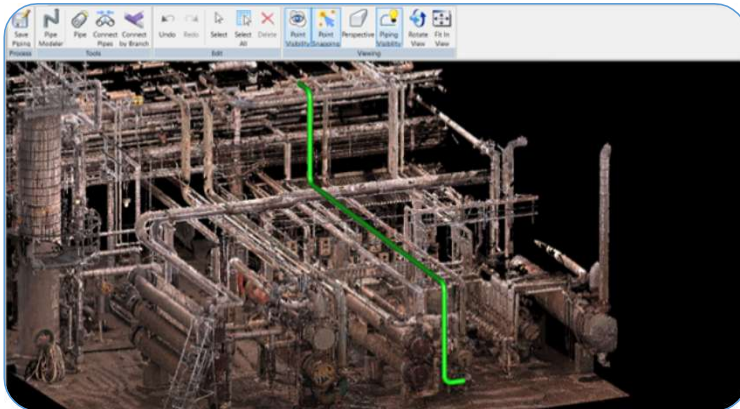
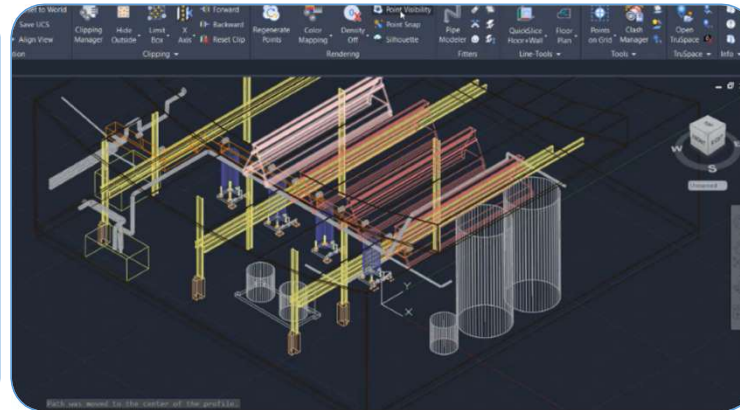
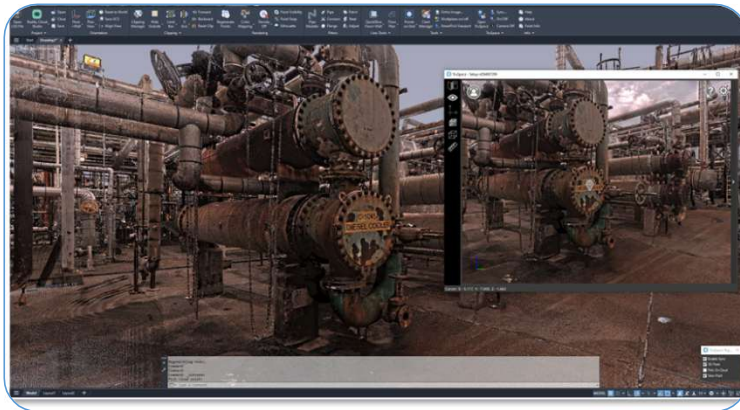

A

CAD

R

RVT

C

C3D

A

P3D

N

MAN

BRIGSCAD

# 스캔부터 분석까지, Leica Geosystems로 구현하는 Reality Capture

- Deliver – 데이터 공유
  - CloudWorx for Revit Viewer
    - Free!
    - License free!
    - Connection to RCS
    - Direct import of e57, las, ptx
    - Clipping & fencing tools
    - Color mapping
    - COE Import/Export  
for better interoperability with 3DR

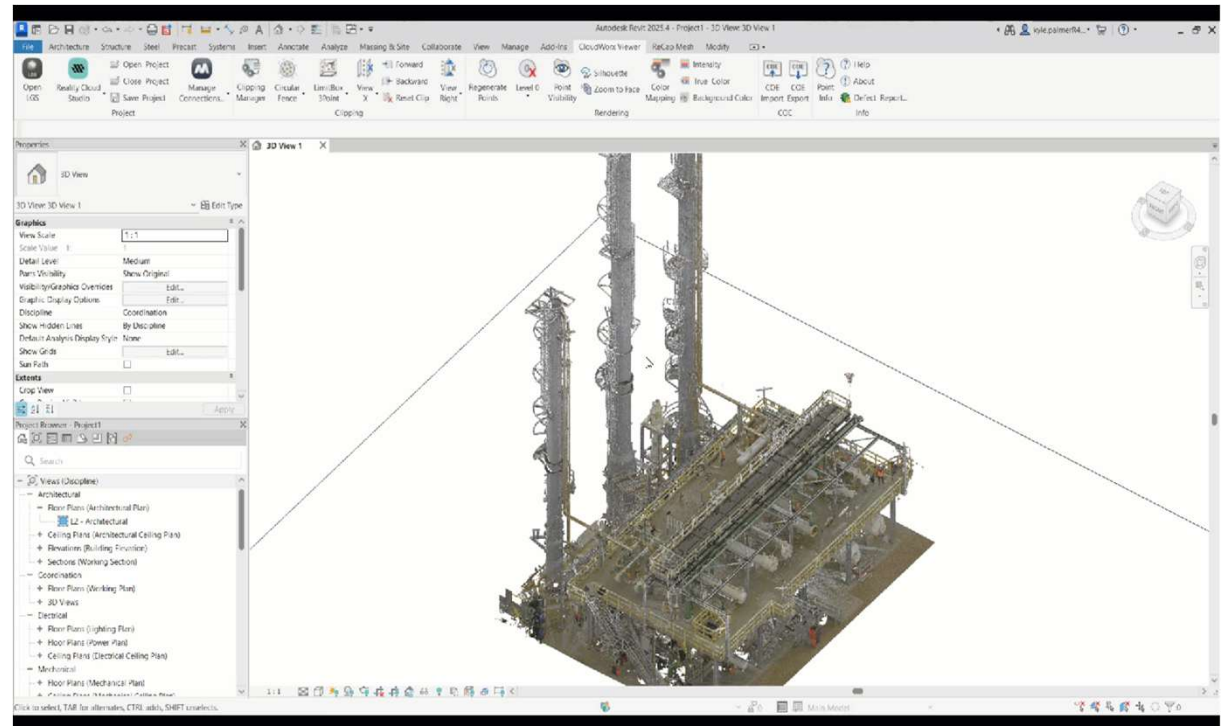

# 스캔부터 분석까지, Leica Geosystems로 구현하는 Reality Capture

- Deliver – 데이터 공유
  - TruView



- 측정 도구 - 거리, 각도, 지름

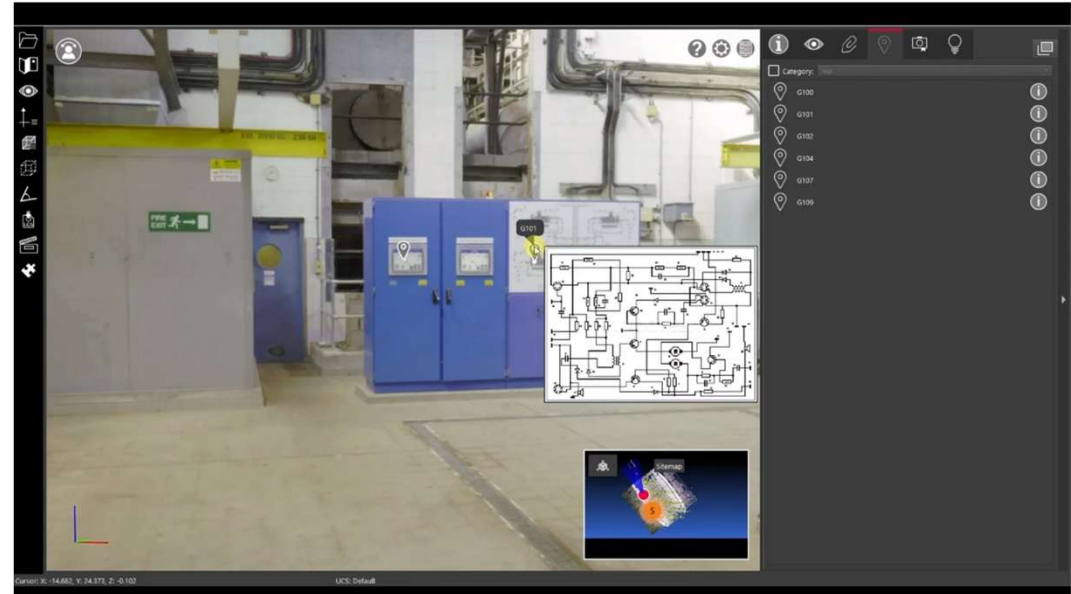

- 지오태그 – 위치에 대한 설명과 사진, 도면, URL등을 첨부

# 스캔부터 분석까지, Leica Geosystems로 구현하는 Reality Capture

- Deliver – 데이터 공유
  - TruView

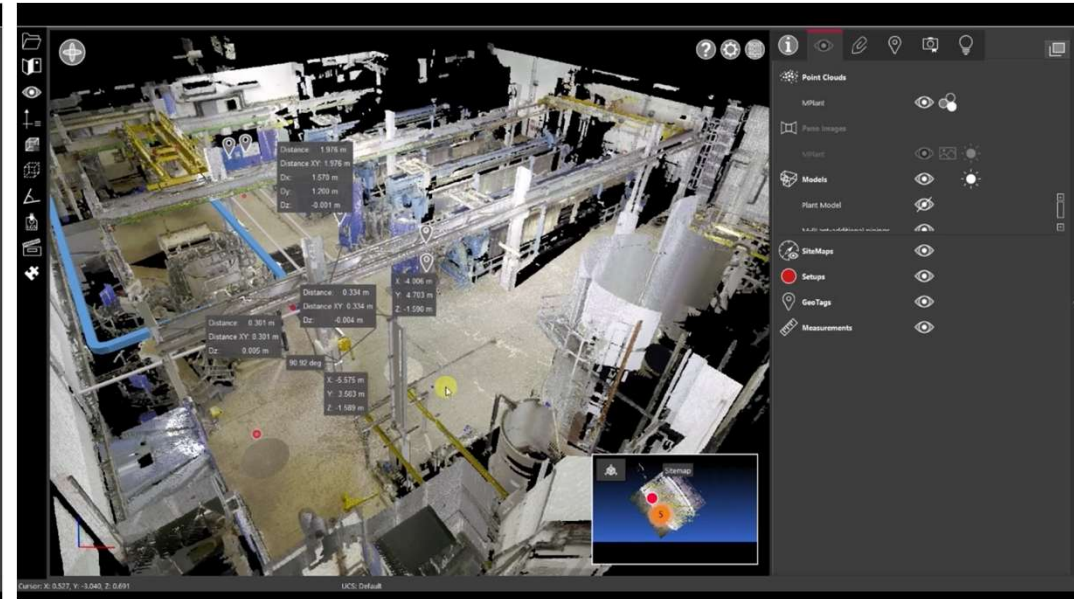
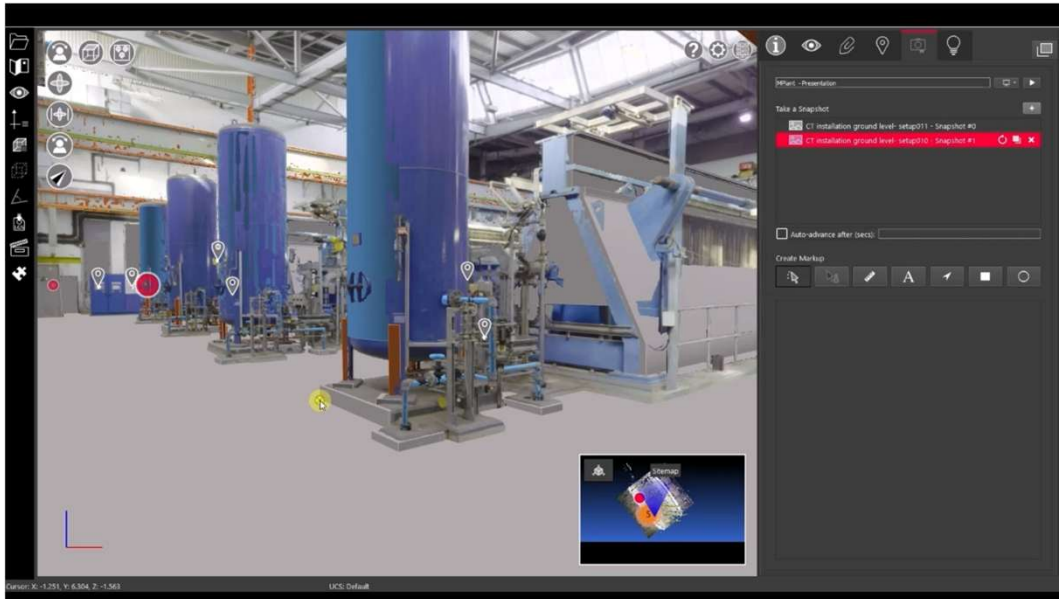

- 스냅샷 – 화면의 장면을 저장하는 기능(위치정보와 코멘트를 공유)
- 모델 파일 불러오기 – IFC, OBJ, COE 형식의 파일을 지원

# 스캔부터 분석까지, Leica Geosystems로 구현하는 Reality Capture

- Deliver – 데이터 공유
  - Cyclone 3DR Viewer

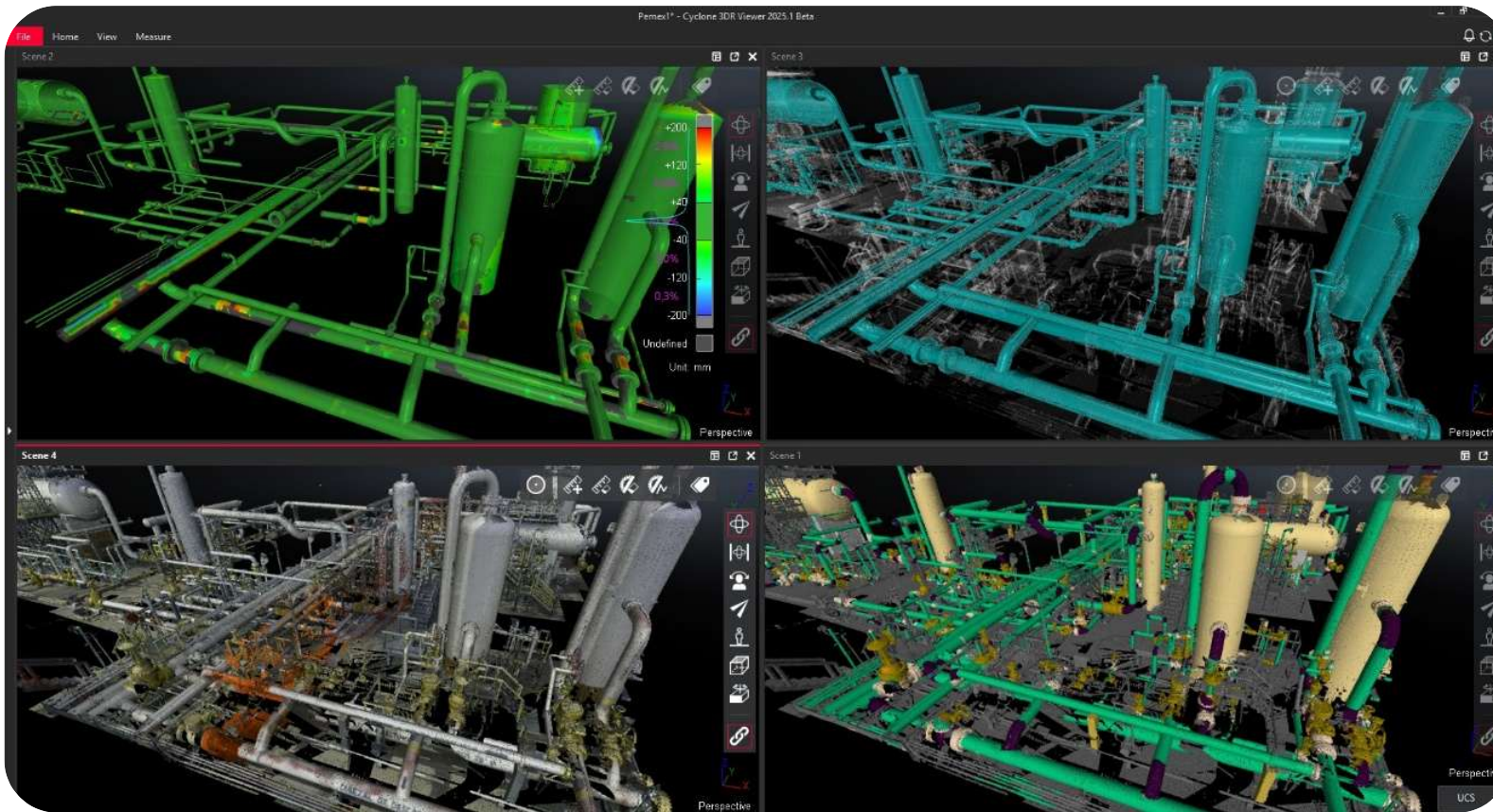

- \*.lgsx
- \*.3dr
- Reality Cloud Studio

# 스캔부터 분석까지, Leica Geosystems로 구현하는 Reality Capture

## Reality Capture의 워크플로우

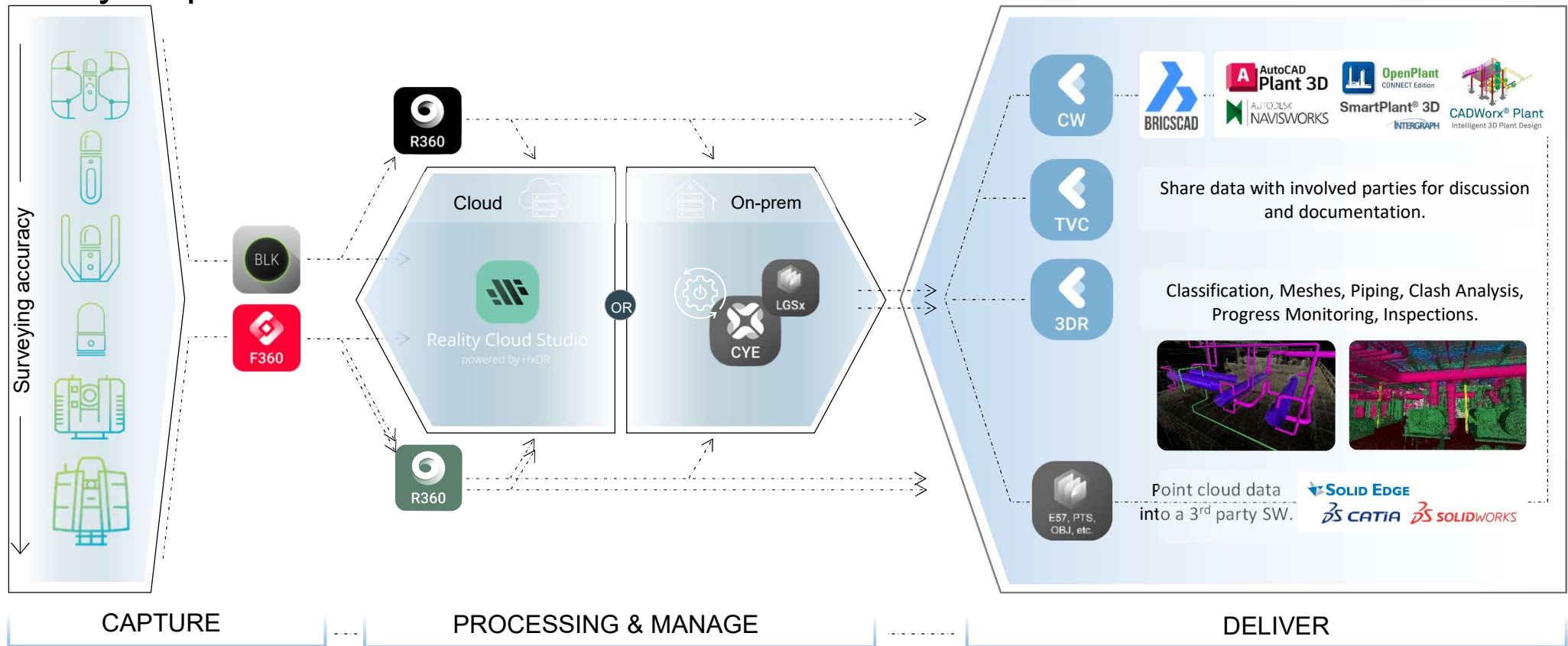

# 스캔부터 분석까지, Leica Geosystems로 구현하는 Reality Capture

## Reality Capture의 워크플로우

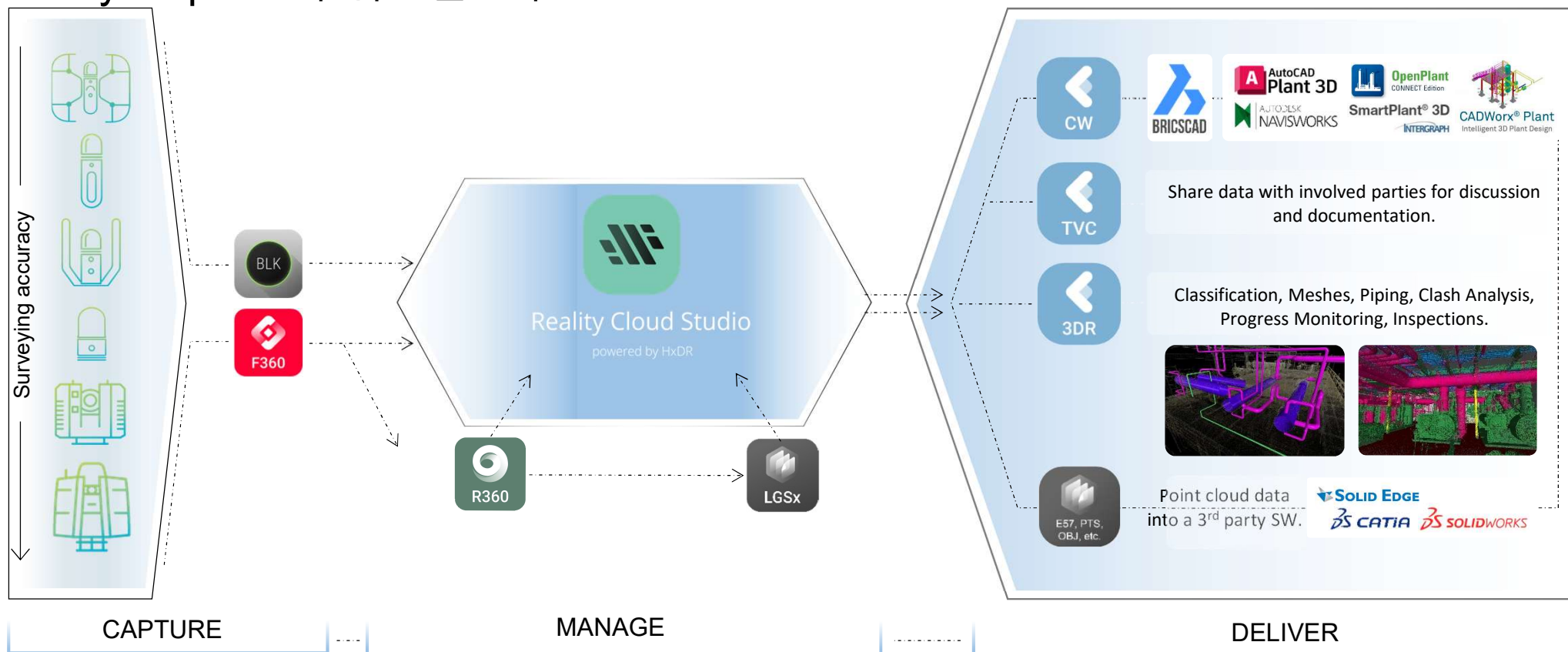

스캔부터 분석까지, Leica Geosystems로 구현하는 Reality Capture

**DIGITAL REALITY, REALIZED.**



**Reality Cloud Studio**

powered by HxDR

# 스캔부터 분석까지, Leica Geosystems로 구현하는 Reality Capture

## ▪ Reality cloud studio - Process

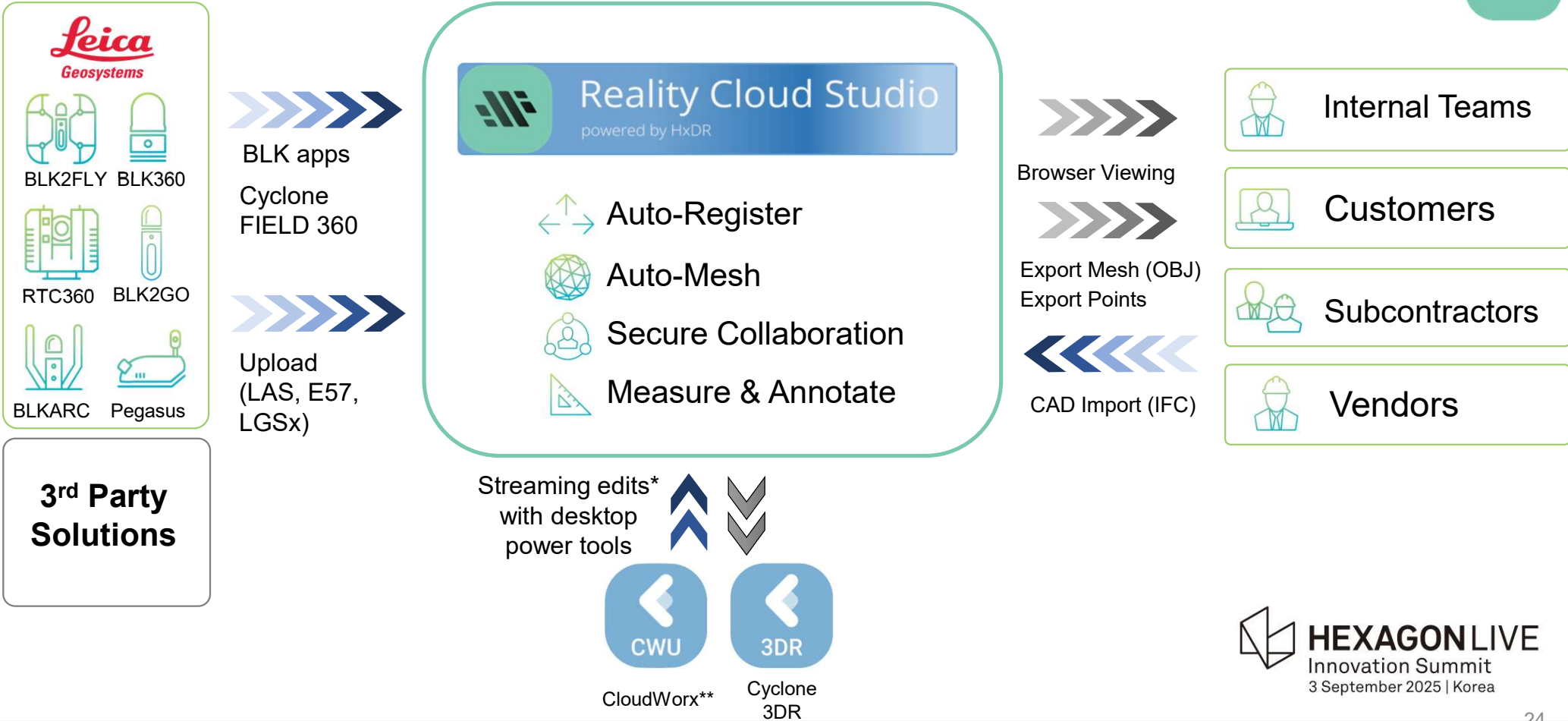

# 스캔부터 분석까지, Leica Geosystems로 구현하는 Reality Capture

- Reality cloud studio – 제품 & 기능

## 1. Import

- 전용 파일 뿐만 아니라 산업 표준 파일을 지원합니다. (.b2g, .lgs, .lgsx, .e57, .ifc, .obj, and .glb)

## 3. Automation Registration

- 완전 자동화된 정합 및 메쉬 생성 워크플로우를 제공합니다.



# 스캔부터 분석까지, Leica Geosystems로 구현하는 Reality Capture

- Reality cloud studio – 제품 & 기능

## 3. Automation Meshing

- 자동 메쉬 기능은 움직이는 물체를 걸러냅니다.

## 4. Visualization & Collaborate

- 이미지, 가상투어, 주석, 측정값 표기등을 3D 공간에 시각화 하고 공유할 수 있습니다.

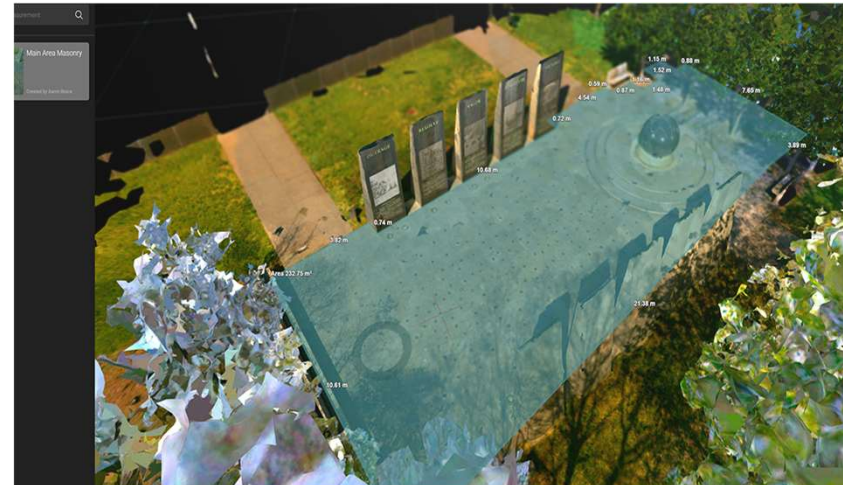

# 스캔부터 분석까지, Leica Geosystems로 구현하는 Reality Capture

- Reality cloud studio – 추가기능
  - **Scan vs BIM**
    - 편차분석
  - **AI Processing Classification**
    - 클라우드 GPU 파워 활용
  - **Scan to BIM**
    - 더 빠른 분류화 작업
  - **Smart Navigation & Visualization**
    - 더 좋아진 데이터 접근성
  - **GeoTag Improvements**
    - 고급 커스터마이징 지원

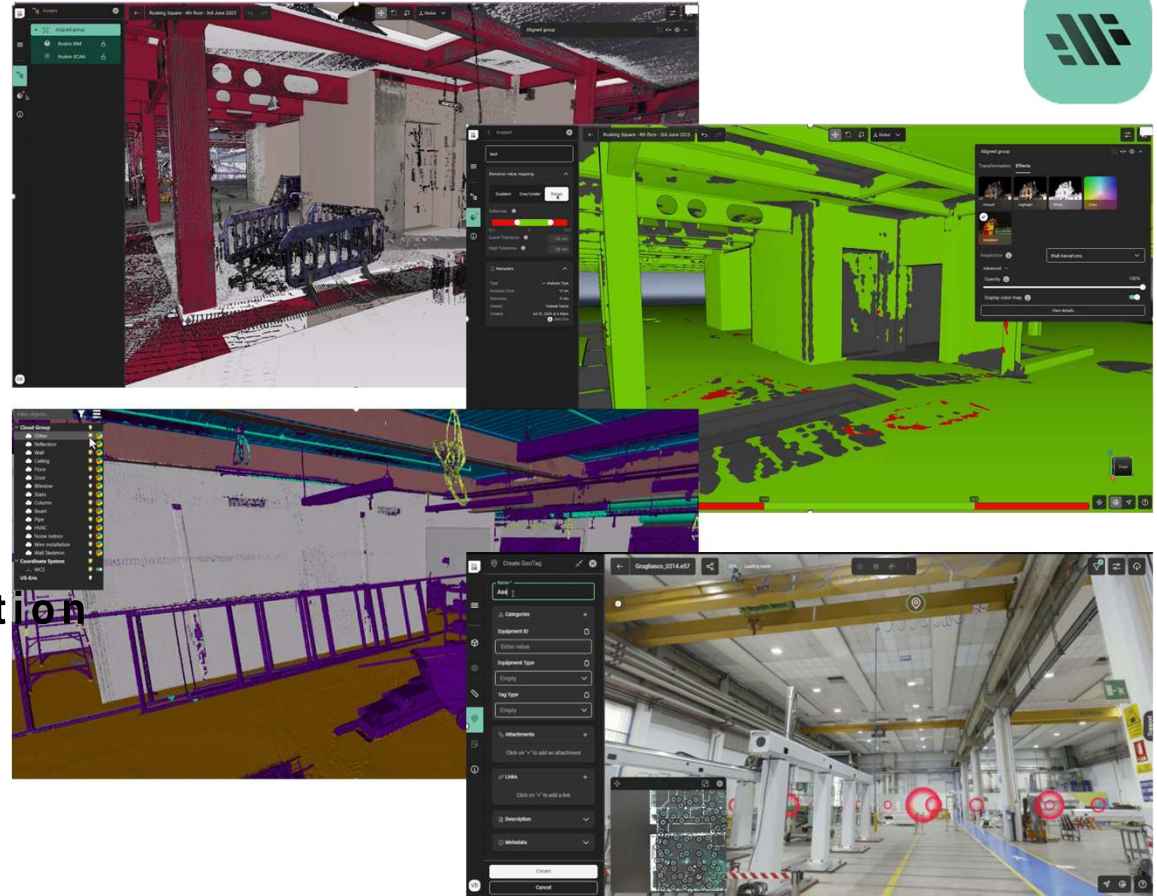

# Q & A

감사합니다.